



MS-CF06

Industrial Computer Board

User Guide

Contents

Regulatory Notices.....	4
Safety Information	7
Specifications	9
Motherboard Overview	11
Rear I/O Panel.....	12
CPU Socket	16
Introduction to the LGA1700 CPU.....	16
CPU & Heatsink Installation.....	17
Memory	18
DIMM1~2: DDR5 DIMM Slots	18
Installing DDR5 UDIMM Memory Module.....	18
Storage	19
SATA1_2, 3_4: SATA 3.0 6Gb/s Ports.....	19
Expansion Slots	20
PCIe1~2: PCIe Expansion Slots	20
PCI1~5: PCI Slots.....	20
Connectors	21
Power Connectors.....	21
JPWR1: 24-Pin ATX Power Connector	21
JPWR2: 8-Pin ATX 12V Power Connector	21
Cooling Connectors	22
CPUFAN1, SYSFAN1~2: CPU/ System Fan Connectors	22
Audio Connectors	23
JAUD1: Front Audio Header (Line-out/ MIC-in)	23
JSPDIF1: S/PDIF Connector	23
USB Connectors	24
JUSB1: USB 2.0 Header	24
JUSB2: USB 2.0 Type-A Port.....	24

Revision

V1.5, 2025/08

Other Connectors.....	25
JFP1: Front Panel Header.....	25
JGPIO1: GPIO Header.....	25
JSMB1: SMBus Header.....	26
JCOM3~6: Serial Port Headers.....	26
JCASE1: Chassis Intrusion Header.....	27
BAT1: CMOS Battery.....	28
Replacing CMOS battery.....	28
Jumpers.....	29
BIOS Setup.....	30
Entering Setup.....	30
The Menu Bar.....	32
Main.....	33
Advanced.....	34
Boot.....	41
Security.....	42
Chipset.....	50
Power.....	51
Save & Exit.....	52
GPIO WDT Programming.....	53
Abstract.....	53
General Purpose IO.....	54
Watchdog Timer.....	55

Regulatory Notices

CE Conformity

This product has been tested and found to comply with the harmonized standards for Information Technology Equipment published under Directives of Official Journal of the European Union.



FCC-B Radio Frequency Interference Statement

This equipment has been tested and found to comply with the limits for a Class B digital device, pursuant to Part 15 of the FCC Rules. These limits are designed to provide reasonable protection against harmful interference in a residential installation. This equipment generates, uses and can radiate radio frequency energy and, if not installed and used in accordance with the instruction manual, may cause harmful interference to radio communications. However, there is no guarantee that interference will not occur in a particular installation. If this equipment does cause harmful interference to radio or television reception, which can be determined by turning the equipment off and on, the user is encouraged to try to correct the interference by one or more of the measures listed below:



- Reorient or relocate the receiving antenna.
- Increase the separation between the equipment and receiver.
- Connect the equipment into an outlet on a circuit different from that to which the receiver is connected.
- Consult the dealer or an experienced radio/television technician for help.

Notice 1

The changes or modifications not expressly approved by the party responsible for compliance could void the user's authority to operate the equipment.

Notice 2

Shielded interface cables and AC power cord, if any, must be used in order to comply with the emission limits.

This device complies with Part 15 of the FCC Rules. Operation is subject to the following two conditions:

1. This device may not cause harmful interference, and
2. This device must accept any interference received, including interference that may cause undesired operation.

WEEE Statement

Under the European Union (“EU”) Directive on Waste Electrical and Electronic Equipment, Directive 2012/19/EU, products of “electrical and electronic equipment” cannot be discarded as municipal waste anymore and manufacturers of covered electronic equipment will be obligated to take back such products at the end of their useful life.



Chemical Substances Information

In compliance with chemical substances regulations, such as the EU REACH Regulation (Regulation EC No. 1907/2006 of the European Parliament and the Council), MSI provides the information of chemical substances in products at:

<https://csr.msi.com/global/index>

Battery Information

Please take special precautions if this product comes with a battery.

- Danger of explosion if battery is incorrectly replaced. Replace only with the same or equivalent type recommended by the manufacturer.
- Avoid disposal of a battery into fire or a hot oven, or mechanically crushing or cutting of a battery, which can result in an explosion.
- Avoid leaving a battery in an extremely high temperature or extremely low air pressure environment that can result in an explosion or the leakage of flammable liquid or gas.
- Do not ingest battery. If the coin/button cell battery is swallowed, it can cause severe internal burns and can lead to death. Keep new and used batteries away from children.

European Union:



Batteries, battery packs, and accumulators should not be disposed of as unsorted household waste. Please use the public collection system to return, recycle, or treat them in compliance with the local regulations.

BSMI:



廢電池請回收

For better environmental protection, waste batteries should be collected separately for recycling or special disposal.

California, USA:



The button cell battery may contain perchlorate material and requires special handling when recycled or disposed of in California.

For further information please visit:

<http://www.dtsc.ca.gov/hazardouswaste/perchlorate/>

Environmental Policy

- The product has been designed to enable proper reuse of parts and recycling and should not be thrown away at its end of life.
- Users should contact the local authorized point of collection for recycling and disposing of their end-of-life products.
- Visit the MSI website and locate a nearby distributor for further recycling information.
- Users may also reach us at gpcontdev@msi.com for information regarding proper disposal, take-back, recycling, and disassembly of MSI products.
- Please visit <https://us.msi.com/page/recycling> for information regarding the recycling of your product in the US.



Copyright and Trademarks Notice



Copyright © Micro-Star Int'l Co., Ltd. All rights reserved. The MSI logo used is a registered trademark of Micro-Star Int'l Co., Ltd. All other marks and names mentioned may be trademarks of their respective owners. No warranty as to accuracy or completeness is expressed or implied. MSI reserves the right to make changes to this document without prior notice.



The terms HDMI™, HDMI™ High-Definition Multimedia Interface, HDMI™ Trade dress and the HDMI™ Logos are trademarks or registered trademarks of HDMI™ Licensing Administrator, Inc.

Technical Support

If a problem arises with your product and no solution can be obtained from the user's manual, please contact your place of purchase or local distributor. Alternatively, please visit <https://www.msi.com/support/> for further guidance.

Safety Information



Please read and follow these safety instructions carefully before installing, operating or performing maintenance on the equipment.

General Safety Instructions

- Always read the safety instructions carefully.
- Keep this User's Manual for future reference.
- Keep this equipment in a dry, humidity-free environment.
- Ensure that all components are securely connected to prevent issues during operation.
- Do not cover the air openings to prevent overheating.
- Avoid spilling liquids into the equipment to prevent damage or electrical shock.
- Do not leave the equipment in an unconditioned environment. Storage temperatures above 60°C (140°F) may cause damage.

Electrostatic Discharge (ESD) Precautions

The components included in this package are sensitive to electrostatic discharge. Follow these guidelines to prevent ESD-related damage:

- Hold the motherboard by the edges to avoid touching sensitive components.
- Wear an ESD wrist strap. If not available, discharge static electricity by touching a metal object before handling.
- When not installed, store the motherboard in an electrostatic shielding container or place it on an anti-static pad.

Power Safety

- Always turn off the power supply and unplug the power cord from the outlet before installing or removing any component.
- Ensure the electrical outlet provides the same voltage as indicated on the PSU before connecting.
- Arrange the power cord to avoid tripping hazards or damage. Do not place objects over the power cord.

Installation Instructions

- Lay the equipment on a stable, flat surface before setting it up.
- Before turning on the system, ensure there are no loose screws or metal components on the motherboard or within the system case.
- Do not boot the computer before completing all installations. Premature booting can cause permanent damage to components and pose safety risks.

When to Contact Service Personnel

Immediately consult service personnel if any of the following situations arise:

- The power cord or plug is damaged.
- Liquid has entered the equipment.
- The equipment has been exposed to moisture.
- The equipment does not function as described in the User Guide.
- The equipment has been dropped or physically damaged.
- The equipment shows visible signs of breakage.

Specifications

Model	MS-CF06
Dimensions	305(L)mm x 244(W)mm x 1.6(H)mm, ATX-Size
Processor	<ul style="list-style-type: none"> • 14th Gen Intel® Raptor Lake-S Refresh i9/i7/i5/i3 IOTG Series Processor, Max 65W • 13th Gen Intel® Raptor Lake-S i9/i7/i5/i3 Pentium®/ Celeron® IOTG Series Processor, Max 65W • 12th Gen Intel® Alder Lake-S i9/i7/i5/i3 Pentium®/ Celeron® IOTG Series Processor, Max 65W
Chipset	Intel® H610E
Memory	<ul style="list-style-type: none"> • 2 x DDR5 UDIMM slots (288-pin, vertical) <ul style="list-style-type: none"> - Dual-Channel DDR5, Non-ECC - Up to 4800 MT/s - Up to 64GB
Network	<ul style="list-style-type: none"> • 1 x Intel® I219-LM PCIe 1Gbps LAN (LAN1) • 1 x Intel® I226-V PCIe 2.5Gbps LAN (LAN2)
Storage	<ul style="list-style-type: none"> • 4 x SATA 3.0 6Gb/s connectors <ul style="list-style-type: none"> - Supports AHCI mode
Expansion Slots	<ul style="list-style-type: none"> • 1 x PCIe 5.0 x16 slot, up to 75W (PCIe1) • 1 x PCIe 5.0 x16 slot (PCIe 5.0 x4 signal, PCIe2) • 5 x PCI slots (PCI1~5)
USB	<ul style="list-style-type: none"> • 2 x USB 10Gbps ports (rear, USB2) • 2 x USB 5Gbps ports (rear, USB3) • 5 x USB 2.0 ports (480 Mbps) (2 x rear, 3 x Internal with one vertical Type-A)
Audio	<ul style="list-style-type: none"> • Realtek® ALC897 High Definition Audio Codec
Graphics	<ul style="list-style-type: none"> • 1 x HDMI™ 1.4b up to 4096x2160 @24Hz • 1 x VGA, up to 1920x1200 @60Hz • 2 independent display modes supported <ul style="list-style-type: none"> - HDMI™ - VGA
Power	<ul style="list-style-type: none"> • 1 x 24-pin ATX power connector • 1 x 8-pin 12V ATX power connector

Continued on next column

Model	MS-CF06
Rear I/O	<ul style="list-style-type: none"> • 1 x PS/2® Keyboard & Mouse Port • 1 x HDMI™ connector (1.4b) • 1 x VGA Port • 2 x DB-9 Serial ports <ul style="list-style-type: none"> - COM1: Supports RS-232/422/485, 0V/5V/12V, Auto-flow Control - COM2: Supports RS-232, 0V/5V/12V • 1 x 1 Gbps RJ-45 LAN port (LAN1) • 1 x 2.5 Gbps RJ-45 LAN port (LAN2) • 2 x USB 2.0 ports (USB1) • 2 x Dual Stacked USB 3.2 Type-A ports <ul style="list-style-type: none"> - 2 xUSB 10Gbps Type-A ports (USB2) - 2 xUSB 5Gbps Type-A ports (USB3) • 1 x Line-out jack • 1 x Mic-in jack
Onboard Connectors	<ul style="list-style-type: none"> • 1 x 4-pin PWM CPU fan connector • 2 x 4-pin PWM system fan connectors • 1 x Front panel header • 1 x Front audio header (Line-out & Mic-in) • 1 x S/PDIF connector • 4 x Serial port headers • 1 x GPIO header • 1 x SMBus header • 1 x USB 2.0 header (480 Mbps) • 1 x USB 2.0 Type-A port (480 Mbps) • 1 x Chassis Intrusion header • 2 x COM voltage select jumpers • 5 x PCI voltage select jumpers • 1 x Clear CMOS jumper • 1 x ME jumper • 1 x AT/ ATX mode select jumper
OS Support	<ul style="list-style-type: none"> • Windows 10 IoT Enterprise 2021 LTSC (64-bit) • Windows 11 IoT Enterprise LTSC 24H2 (64-Bit) • Linux Kernel 5.xx, Ubuntu 22.04 LTS Pre-scan
Certification	CE, FCC Class B, BSMI, RCM, VCCI
Environment	<ul style="list-style-type: none"> • Operating Temperature: 0 ~ 60°C • Storage Temperature: -20 ~ 80°C • Relative Humidity: 10 ~ 90%, non-condensing

Motherboard Overview

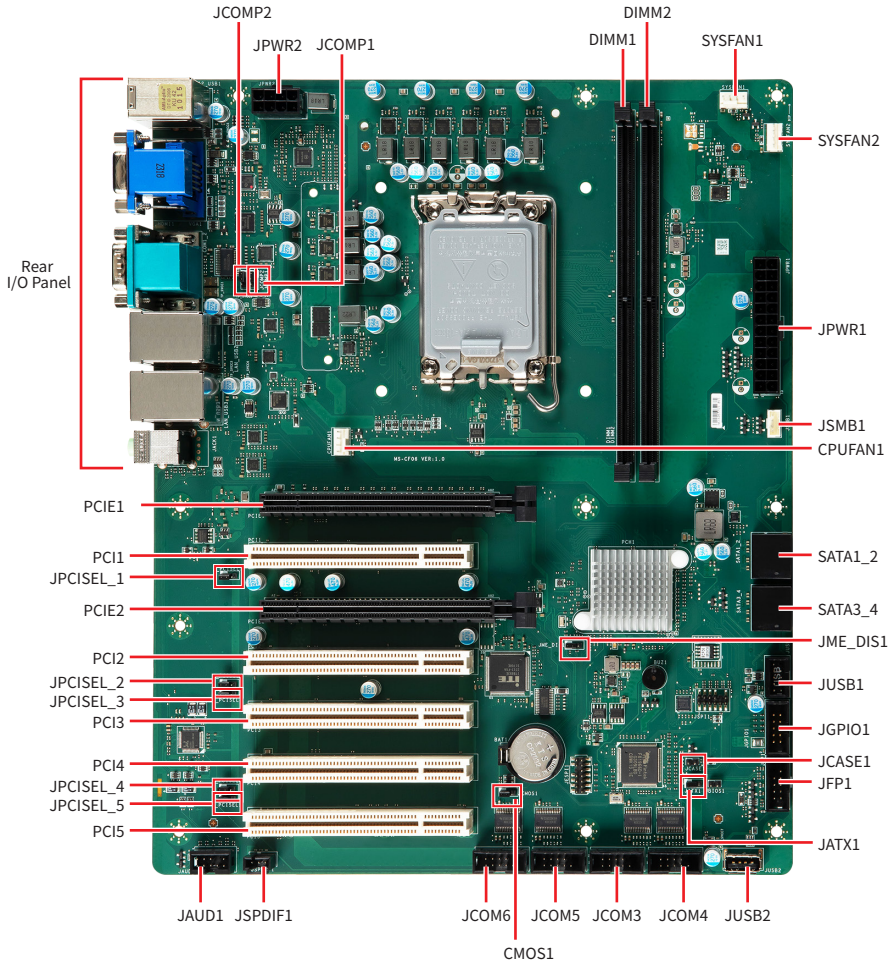

Rear I/O Panel

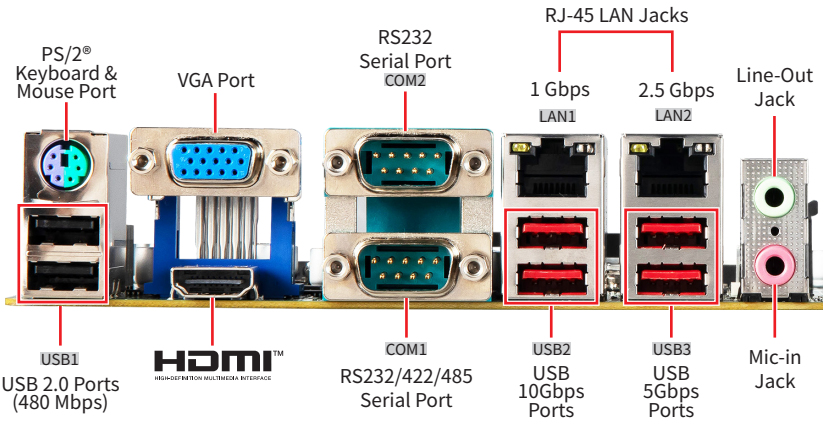

PS/2® Keyboard/ Mouse Port

The PS/2® keyboard/ mouse DIN connector is for PS/2® keyboard/ mouse.

USB 2.0 Ports

These connectors are provided for USB peripheral devices. (Speed up to **480 Mbps**)



Use high-speed devices for USB 5Gbps ports and above, and connect low-speed devices like mice or keyboards to USB 2.0 ports.

VGA Port

The VGA port supports monitors and other VGA interface devices.

HDMI™ Connector **HDMI™**

HDMI™ is an all-digital interface for uncompressed audio/video streams, supporting standard, enhanced, or high-definition video, and multi-channel digital audio on a single cable.

RS232 Serial Port

The serial port is a 16550A high speed communications port that sends/receives 16 bytes FIFOs. It supports barcode scanners, barcode printers, bill printers, credit card machine, etc.

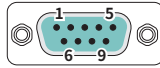

RS232		
PIN	SIGNAL	DESCRIPTION
1	NDCD	Data Carrier Detect
2	NSIN	Signal In
3	NSOUT	Signal Out
4	NDTR	Data Terminal Ready
5	GND	Signal Ground
6	NDSR	Data Set Ready
7	NRTS	Request To Send
8	NCTS	Clear To Send
9	VCC_COM	VCC_COM

RS232/422/485 Serial Port

The serial port is a 16550A high speed communications port that sends/receives 16 bytes FIFOs. It supports barcode scanners, barcode printers, bill printers, credit card machine, etc.

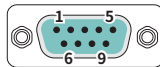

RS232		
PIN	SIGNAL	DESCRIPTION
1	NDCD	Data Carrier Detect
2	NSIN	Signal In
3	NSOUT	Signal Out
4	NDTR	Data Terminal Ready
5	GND	Signal Ground
6	NDSR	Data Set Ready
7	NRTS	Request To Send
8	NCTS	Clear To Send
9	VCC_COM	VCC_COM

RS422		
PIN	SIGNAL	DESCRIPTION
1	422 TXD-	Transmit Data, Negative
2	422 TXD+	Transmit Data, Positive
3	422 RXD+	Receive Data, Positive
4	422 RXD-	Receive Data, Negative
5	GND	Signal Ground
6	NC	No Connection
7	NC	No Connection
8	NC	No Connection
9	NC	No Connection

RS485		
PIN	SIGNAL	DESCRIPTION
1	D-	Data, Negative
2	D+	Data, Positive
3	NC	No Connection
4	NC	No Connection
5	GND	Ground
6	NC	No Connection
7	NC	No Connection
8	NC	No Connection
9	NC	No Connection

1 Gbps RJ-45 LAN Jack

The standard RJ-45 LAN jack is provided for connection to the Local Area Network (LAN). You can connect a network cable to it.

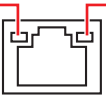
Link/ Activity LED			Speed LED	
Status	Description		Status	Description
<input type="radio"/> Off	No link	<input type="radio"/> Off	10 Mbps	
<input checked="" type="radio"/> Yellow	Linked	<input checked="" type="radio"/> Green	100 Mbps	
<input checked="" type="radio"/> Blinking	Data activity	<input checked="" type="radio"/> Orange	1 Gbps	

2.5 Gbps RJ-45 LAN Jack

The standard RJ45 LAN jack is provided for connection to the Local Area Network (LAN). You can connect a network cable to it.

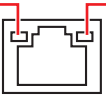
Link/ Activity LED			Speed LED	
Status	Description		Status	Description
<input type="radio"/> Off	No link	<input type="radio"/> Off	10/100 Mbps	
<input checked="" type="radio"/> Yellow	Linked	<input checked="" type="radio"/> Green	1000 Mbps	
<input checked="" type="radio"/> Blinking	Data activity	<input checked="" type="radio"/> Orange	2.5 Gbps	

USB 10Gbps Ports

This connector delivers high-speed data transfer for various devices, such as storage devices, hard drives, video cameras, etc. It supports data transfer rates up to **10 Gbps**.

USB 5 Gbps Ports

The USB (Universal Serial Bus) port is for attaching USB devices such as keyboards, mouse, or other USB-compatible devices. It supports data transfer rates up to **5 Gbps**.

Line-Out Jack

This connector is provided for headphones or speakers.

Mic-In Jack

This connector is provided for microphones.

Component Contents

Component	Page
CPU Socket	16
Memory	18
DIMM1~2: DDR5 DIMM Slots	18
Storage	19
SATA1_2, 3_4: SATA 3.0 6Gb/s Ports	19
Expansion Slots	20
PCIE1~2: PCIe Expansion Slots	20
PCI1~5: PCI Slots	20
Connectors	21
Power Connectors	21
JPWR1: 24-Pin ATX Power Connector	21
JPWR2: 8-Pin ATX 12V Power Connector	21
Cooling Connectors	22
CPUFAN1, SYSFAN1~2: CPU/ System Fan Connectors	22
Audio Connectors	23
JAUD1: Front Audio Header (Line-out/ MIC-in)	23
JSPDIF1: S/PDIF Connector	23
USB Connectors	24
JUSB1: USB 2.0 Header	24
JUSB2: USB 2.0 Type-A Port	24
Other Connectors	25
JFP1: Front Panel Header	25
JGPIO1: GPIO Header	25
JSMB1: SMBus Header	26
JCOM3~6: Serial Port Headers	26
JCASE1: Chassis Intrusion Header	27
BAT1: CMOS Battery	28
Replacing CMOS battery	28
Jumpers	29

CPU Socket

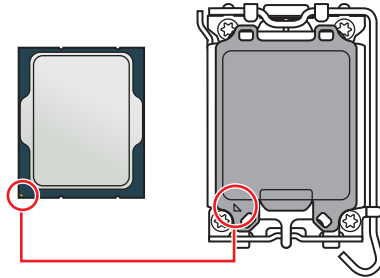
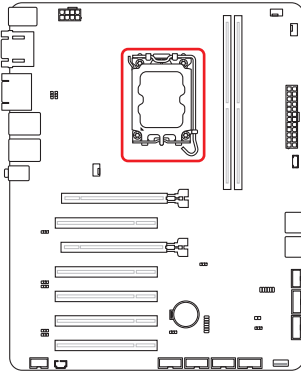

Introduction to the LGA1700 CPU

The surface of the LGA1700 CPU has four notches and a golden triangle to assist in correctly lining up the CPU for motherboard placement. The golden triangle is the Pin 1 indicator.

Important

- Always unplug the power cord from the power outlet before installing or removing the CPU.
- When **installing a CPU**, always remember to install a CPU heatsink. A CPU heatsink is necessary to prevent overheating and maintain system stability.
- Confirm that the CPU heatsink has formed a tight seal with the CPU before booting your system.
- **Overheating** can seriously damage the CPU and motherboard. Always make sure the cooling fans work properly to protect the CPU from overheating. Be sure to apply an even layer of thermal paste (or thermal tape) between the CPU and the heatsink to enhance heat dissipation.
- Whenever the CPU is not installed, always protect the CPU socket pins by covering the socket with the plastic cap.
- If you purchased a separate CPU and heatsink/ cooler, Please refer to the documentation in the heatsink/ cooler package for more details about installation.

CPU & Heatsink Installation

Use appropriate ground straps, gloves and ESD mats to protect yourself from electrostatic discharge (ESD) while installing the processor.

 **Important**

Images are for illustration purposes only; actual parts may vary.



<https://youtu.be/KMf9oIDsGes>

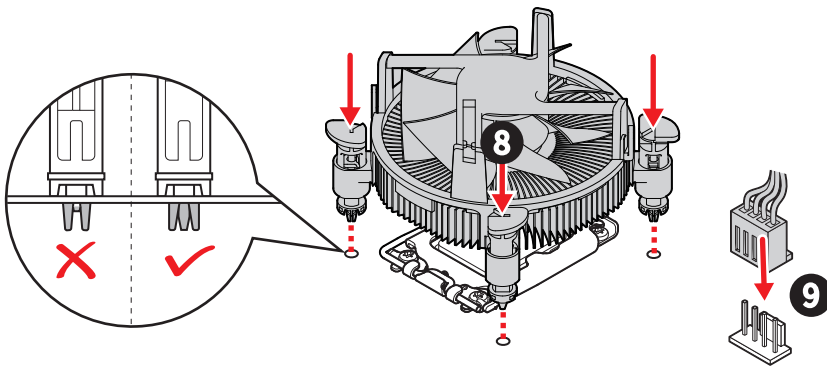
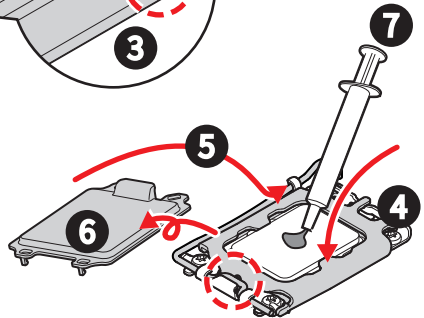
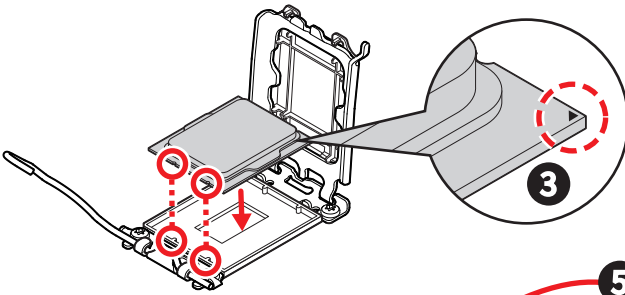
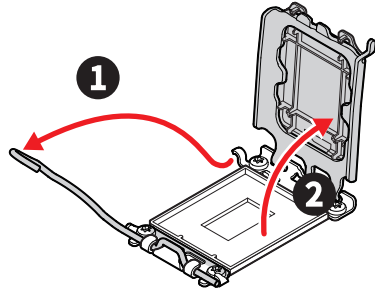

Memory

DIMM1~2: DDR5 DIMM Slots

The DIMM slots is intended for memory modules.

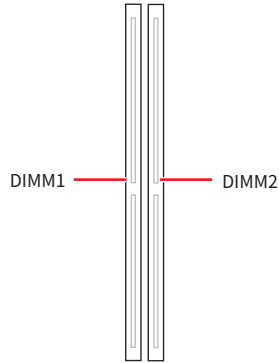
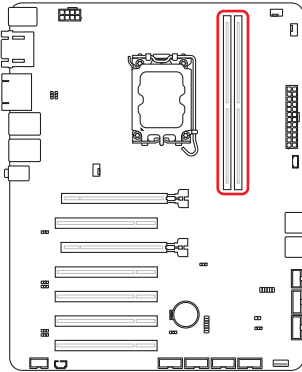

Installing DDR5 UDIMM Memory Module

1. Open the side clips to unlock the DIMM slot.
2. Insert the DIMM vertically into the slot, ensuring that the off-center notch at the bottom aligns with the slot.
3. Push the DIMM firmly into the slot until it clicks and the side clips automatically close.
4. Verify that the side clips have securely locked the DIMM in place.

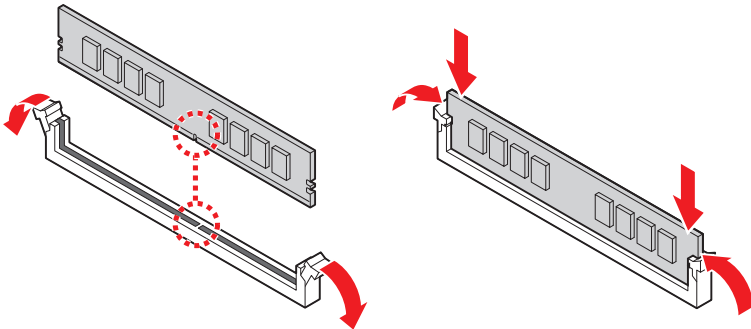

Important

- Always insert memory modules in the **DIMM2** slot first.
- You can barely see the golden finger if the DIMM is properly inserted in the DIMM slot.
- To ensure system stability for Dual channel mode, memory modules must be of the same type, number and density.

Storage

SATA1_2, 3_4: SATA 3.0 6Gb/s Ports

These connectors are SATA 6Gb/s interface port, it can connect to one SATA device.

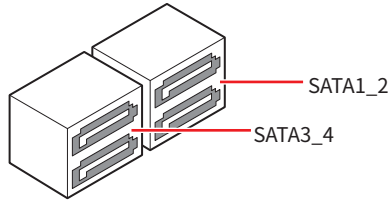
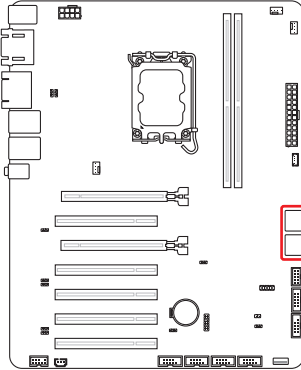

Important

- *These SATA connectors support hot plug.*
- *Please do not fold the SATA cable at a 90-degree angle. Data loss may result during transmission otherwise.*
- *SATA cables have identical plugs on either sides of the cable. However, it is recommended that the flat connector be connected to the motherboard for space saving purposes.*

Expansion Slots

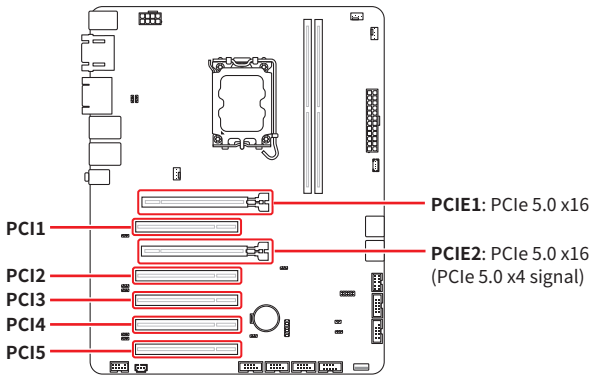

PCIE1~2: PCIe Expansion Slots

The PCI Express(Peripheral Component Interconnect Express) slots support PCIe interface expansion cards.

PCI1~5: PCI Slots

The PCI (Peripheral Component Interconnect) slots support PCI interface expansion cards.

Important

When adding or removing expansion cards, make sure that you unplug the power supply first. Meanwhile, read the documentation for the expansion card to configure any necessary hardware or software settings for the expansion card, such as jumpers, switches or BIOS configuration.

Connectors

Power Connectors

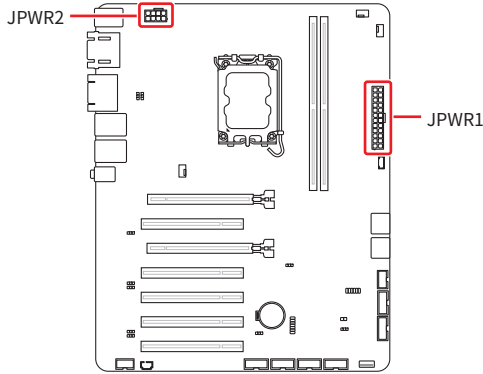

JPWR1: 24-Pin ATX Power Connector

This connector allows you to connect an ATX power supply.

	1	+3.3V	13	+3.3V
	2	+3.3V	14	-12V
	3	GND	15	GND
	4	+5V	16	PS-ON#
	5	GND	17	GND
	6	+5V	18	GND
	7	GND	19	GND
	8	PWR OK	20	Res
	9	5VSB	21	+5V
	10	+12V	22	+5V
	11	+12V	23	+5V
	12	+3.3V	24	GND

JPWR2: 8-Pin ATX 12V Power Connector

This connector allows you to connect an ATX power supply.

	1	GND	5	P12V
	2	GND	6	P12V
	3	GND	7	P12V
	4	GND	8	P12V

Important

Make sure that all the power cables are securely connected to a proper power supply to ensure stable operation of the system.

Cooling Connectors

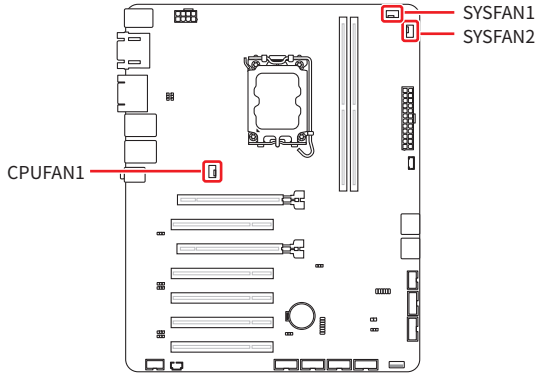

CPUFAN1, SYSFAN1~2: CPU/ System Fan Connectors

The fan connector supports CPU/ system cooling fans with +12V. When connecting the wire to the connectors, always note that the red wire is the positive and should be connected to the +12V; the black wire is Ground and should be connected to GND.

CPUFAN1 SYSFAN1~2	4  1	1	GND	2	FAN POWER
		3	FAN SENSE	4	FAN_PWM

 **Important**

Please refer to the recommended CPU fans at processor's official website or consult the vendors for proper CPU cooling fan.

Audio Connectors

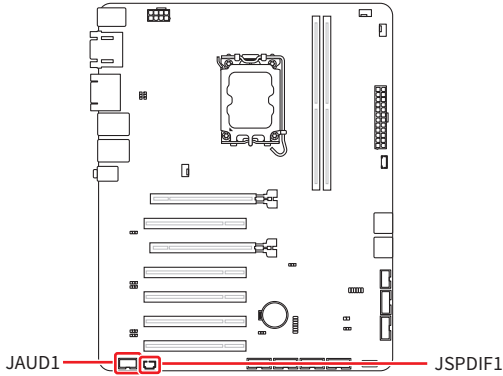

JAUD1: Front Audio Header (Line-out/ MIC-in)

This header allows you to connect front panel audio.

	1	MIC_L	2	GND
	3	MIC_R	4	NC
	5	LINE_OUT_R	6	MIC_JD
	7	Sense	8	No pin
	9	LINE_OUT_L	10	LINE_OUT_JD

JSPDIF1: S/PDIF Connector

This connector is used to connect S/PDIF (Sony & Philips Digital Interconnect Format) interface for digital audio transmission.

	1	POWER
	2	SPDIF
	3	GND

USB Connectors

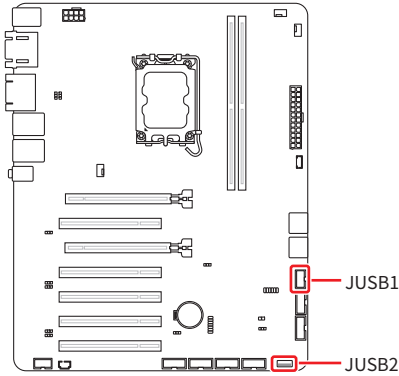

JUSB1: USB 2.0 Header

This header is ideal for connecting USB devices such as keyboard, mouse, or other USB-compatible devices.

	1	POWER	2	POWER
	3	USB_D-	4	USB_D-
	5	USB_D+	6	USB_D+
	7	GND	8	GND
	9	No Pin	10	NC

JUSB2: USB 2.0 Type-A Port

The USB (Universal Serial Bus) connector is for attaching USB devices such as keyboard, mouse, or other USB-compatible devices. It supports speed up to **480 Mbps** data transfer rate.

	1	POWER
	2	USB_D-
	3	USB_D+
	4	GND

Other Connectors

JFP1: Front Panel Header

This front-panel header is provided for electrical connection to the front panel switches & LEDs and is compliant with Intel Front Panel I/O Connectivity Design Guide.

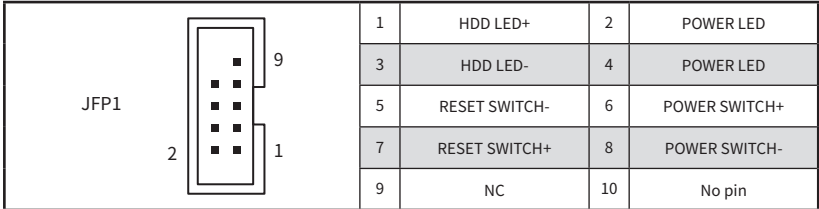

JGPIO1: GPIO Header

This header is provided for the General-Purpose Input/Output (GPIO) peripheral module.

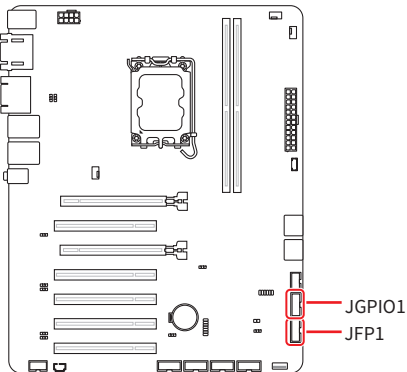
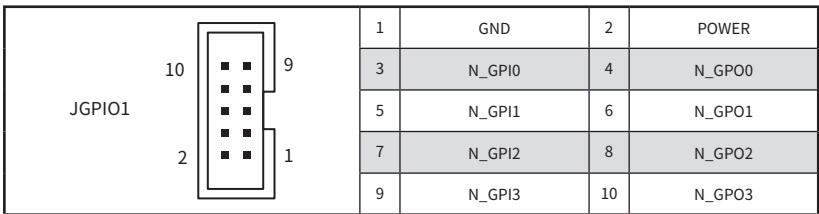

JSMB1: SMBus Header

This header is provided for users to connect System Management Bus (SMBus) interface.

	1	POWER
	2	SMBCLK
	3	SMBDATA
	4	GND

JCOM3~6: Serial Port Headers

These headers are 16550A high speed communications port that sends/ receives 16 bytes FIFOs. You can attach a serial device to it.

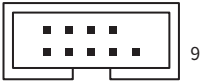
	1	DCD	2	SIN
	3	SOUT	4	DTR
	5	GND	6	DSR#
	7	RTSD	8	CTS#
	9	RI	10	No Pin



Important

After connect COM port box headers to printer, garbage can't be printed when power on/off.

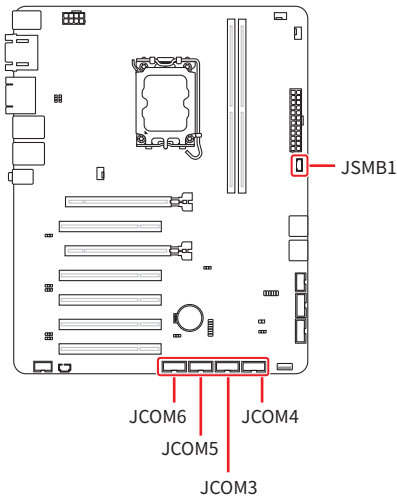

JCASE1: Chassis Intrusion Header

This connector connects to the chassis intrusion switch cable. If the chassis is opened, the chassis intrusion mechanism will be activated. The system will record this status and show a warning message on the screen. To clear the warning, you must enter the BIOS utility and clear the record.

JCASE1



Trigger the
chassis intrusion
event



Normal
(default)

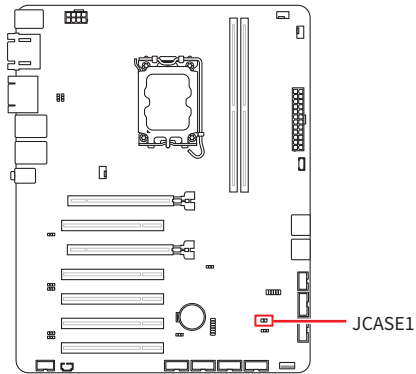

BAT1: CMOS Battery

If the CMOS battery is out of charge, the time in the BIOS will be reset and the data of system configuration will be lost. In this case, you need to replace the CMOS battery.

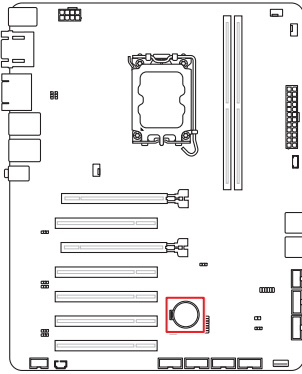

Replacing CMOS battery

1. Push the retainer clip to free the battery.
2. Remove the battery from the socket.
3. Install the new CR2032 coin-cell battery with the + sign facing up. Ensure that the retainer holds the battery securely.

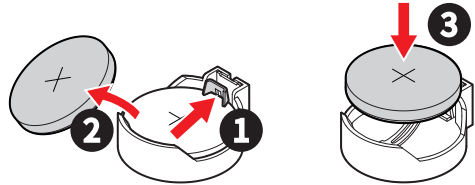

WARNING

KEEP OUT OF REACH OF CHILDREN





- Swallowing can lead to chemical burns, perforation of soft tissue, can death.
- Severe burns can occur within 2 hours of ingestion.
- If you think batteries might have been swallowed or placed inside any part of the body, seek immediate medical attention.

Jumpers

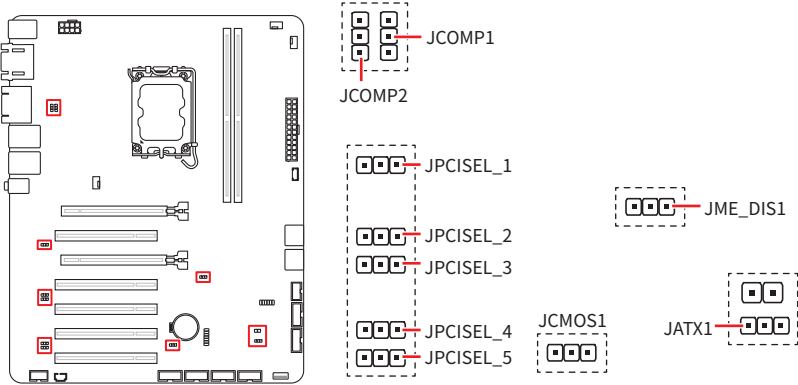
Important

Avoid adjusting jumpers when the system is on; it will damage the motherboard.



Jumper Name	Default Setting	Description
JCOMP1-2	 1	COM Voltage Select Jumper
		1-2: 5V Power (Default) 2-3: 12V Power
JPCISEL_1~5	1 	PCI Voltage Select Jumper
		1-2: 5V (Default) 2-3: 3V
JCMOS1	1 	Clear CMOS Jumper
		1-2: Normal (Default) 2-3: Clear CMOS
JME_DIS1	1 	ME Jumper
		1-2: ME enabled (Default) 2-3: ME disabled
JATX1	 1	AT/ ATX Mode Select Jumper
		1-2: ATX (Default) 2-3: AT

BIOS Setup

This chapter provides information on the BIOS Setup program and allows users to configure the system for optimal use.

Users may need to run the Setup program when:

- An error message appears on the screen at system startup and requests users to run SETUP.
- Users want to change the default settings for customized features.



Important

- *Please note that BIOS update assumes technician-level experience.*
- *As the system BIOS is under continuous update for better system performance, the illustrations in this chapter should be held for reference only.*

Entering Setup

Power on the computer and the system will start POST (Power On Self Test) process. When the message below appears on the screen, press or <F2> key to enter Setup, <F11> key to Boot Menu, <F12> key to PXE Boot .

Press or <F2> to enter SETUP

If the message disappears before you respond and you still wish to enter Setup, restart the system by turning it **OFF** and **On** or pressing the **RESET** button. You may also restart the system by simultaneously pressing <Ctrl>, <Alt>, and <Delete> keys.



Important

The items under each BIOS category described in this chapter are under continuous update for better system performance. Therefore, the description may be slightly different from the latest BIOS and should be held for reference only.

Control Keys

← →	Select Screen
↑ ↓	Select Item
Enter	Select
+ -	Change Value
Esc	Exit
F1	General Help
F7	Previous Values
F9	Optimized Defaults
F10	Save & Reset*
F12	Screenshot capture
<K>	Scroll help area upwards
<M>	Scroll help area downwards

* When you press <F10>, a confirmation window appears and it provides the modification information. Select between **Yes** or **No** to confirm your choice.

Getting Help

Upon entering setup, you will see the Main Menu.

Main Menu

The main menu lists the setup functions you can make changes to. You can use the **arrow keys** (↑ ↓) to select the item. The on-line description of the highlighted setup function is displayed at the bottom of the screen.

Sub-Menu

If you find a right pointer symbol appears to the left of certain fields that means a sub-menu can be launched from this field. A sub-menu contains additional options for a field parameter. You can use **arrow keys** (↑ ↓) to highlight the field and press <Enter> to call up the sub-menu. Then you can use the **control keys** to enter values and move from field to field within a sub-menu. If you want to return to the main menu, just press the <Esc>.

General Help <F1>

The BIOS setup program provides a General Help screen. You can call up this screen from any menu by simply pressing <F1>. The Help screen lists the appropriate keys to use and the possible selections for the highlighted item. Press <Esc> to exit the Help screen.

The Menu Bar

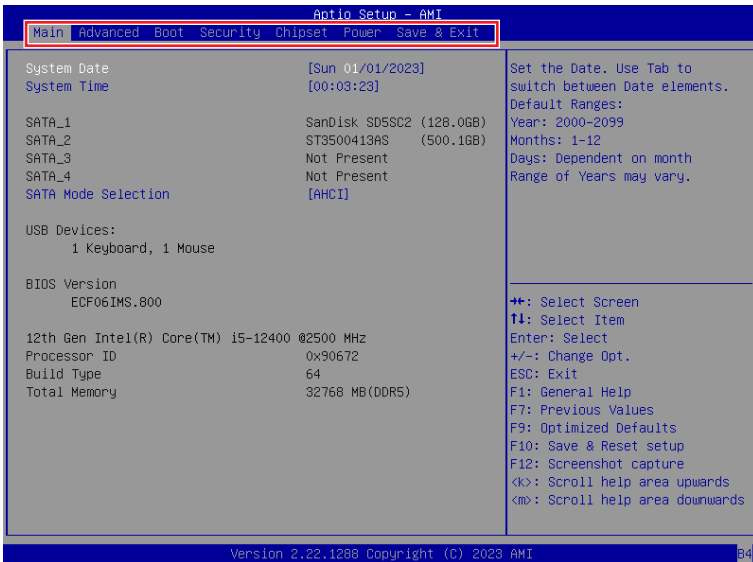

- ▶ **Main**
Use this menu for basic system configurations, such as time, date, etc.
- ▶ **Advanced**
Use this menu to set up the items of special enhanced features.
- ▶ **Boot**
Use this menu to specify the priority of boot devices.
- ▶ **Security**
Use this menu to set supervisor and user passwords.
- ▶ **Chipset**
This menu controls the advanced features of the on-board chipsets.
- ▶ **Power**
Use this menu to specify your settings for power management.
- ▶ **Save & Exit**
This menu allows you to load the BIOS default values or factory default settings into the BIOS and exit the BIOS setup utility with or without changes.

Main

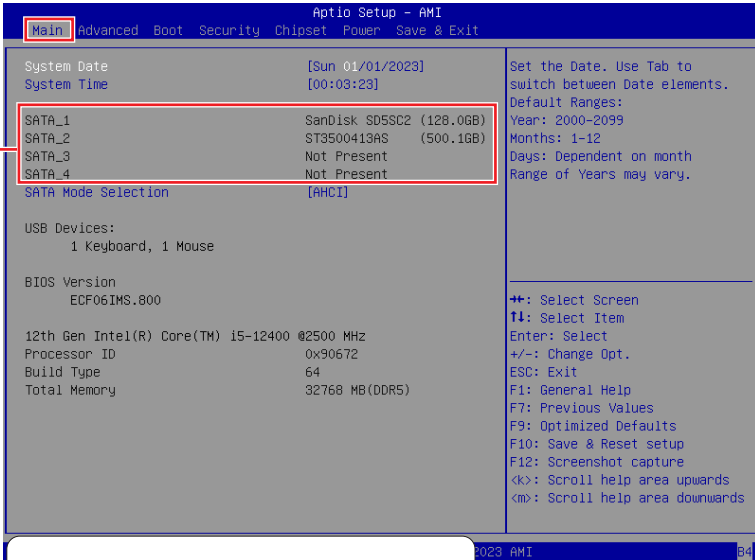

HDD Information

- Display HDD information as plugging in status.

► System Date

This setting allows you to set the system date.

Format: <Day> <Month> <Date> <Year>.

► System Time

This setting allows you to set the system time.

Format: <Hour> <Minute> <Second>.

Advanced

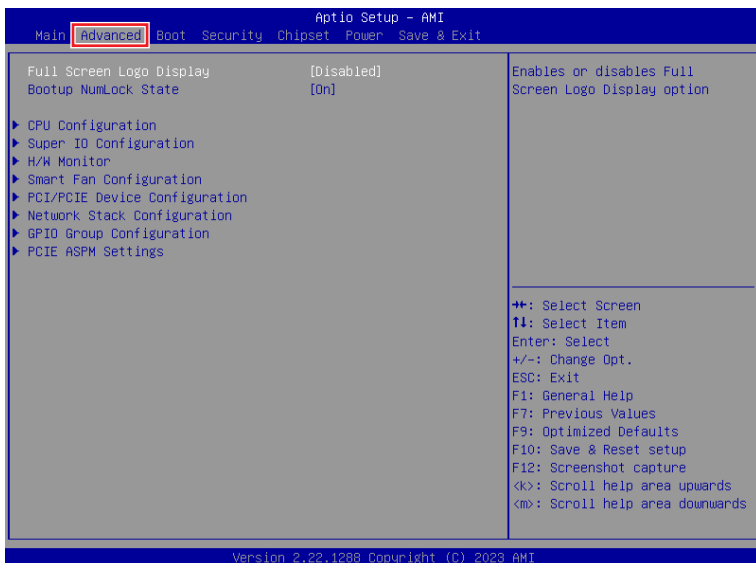

▶ Full Screen Logo Display

This BIOS feature determines if the BIOS should hide the normal POST messages with the motherboard or system manufacturer's full-screen logo.

- [Enabled] BIOS will display the full-screen logo during the boot-up sequence, hiding normal POST messages.
- [Disabled] BIOS will display the normal POST messages, instead of the full-screen logo.

Please note that enabling this BIOS feature often adds 2-3 seconds to the booting sequence. This delay ensures that the logo is displayed for a sufficient amount of time. Therefore, **it is recommended to disable this BIOS feature for faster boot-up.**

▶ Bootup NumLock State

This setting is to set the state of the Num Lock key on the keyboard when the system is powered on.

- [On] Turn on the Num Lock key when the system is powered on.
- [Off] Allow users to use the arrow keys on the numeric keypad.

► CPU Configuration

Advanced	
CPU Configuration	
12th Gen Intel(R) Core(TM) i5-12400	
Processor ID	0x90672
Processor Speed	2500 MHz
P-core Information	
L1 Data Cache	48 KB x 6
L1 Instruction Cache	32 KB x 6
L2 Cache	1280 KB x 6
L3 Cache	18 MB
Intel Virtualization Technology	[Enabled]
Hyper-Threading	[Enabled]
Active Performance-cores	[All]
Intel(R) SpeedStep(tm)	[Enabled]
Intel(R) Speed Shift Technology	[Enabled]
C states	[Enabled]
When enabled, a VMM can utilize the additional hardware capabilities provided by Vanderpool Technology.	
⇧⇧: Select Screen ⇧: Select Item Enter: Select +/-: Change Opt. ESC: Exit F1: General Help F7: Previous Values F9: Optimized Defaults F10: Save & Reset setup F12: Screenshot capture <>: Scroll help area upwards <⇧>: Scroll help area downwards	

► Intel Virtualization Technology

Enables or disables Intel Virtualization technology.

[Enabled] Enables Intel Virtualization technology and allows a platform to run multiple operating systems in independent partitions. The system can function as multiple systems virtually.

[Disabled] Disables this function.

► Hyper-Threading (HT Function)

Enables or disables Intel Hyper-Threading technology.

The processor uses Hyper-Threading technology to improve utilization of the CPU resources and potentially increasing overall performance by allowing it to handle multiple threads simultaneously. If you disable the function, it will restricts the CPU to operate as a single-threaded processor, with only one logical core per physical core. Please disable this item if your operating system does not support HT Function or unreliability and instability may occur.

► Active Performance-cores

Select the number of active Performance-cores (P-cores).

► Intel(R) SpeedStep(TM)

Enhanced Intel SpeedStep® Technology enables the OS to control and activate performance states (P-States) of the processor.

[Enabled] When enabled, Intel SpeedStep® technology is activated. This technology allows the processor to manage its power consumption via performance state (P-State) transitions.

[Disabled] Disables this function

► **Intel(R) Speed Shift Technology**

Intel® Speed Shift Technology is an energy-efficient method that allows frequency control by hardware rather than the OS.

[Enabled] When enabled, Intel® Speed Shift Technology is activated.
The technology enables the management of processor power consumption via hardware performance state (P-State) transitions.

[Disabled] Disable this function.

► **C States**

This setting controls the C-States (CPU Power states).

[Enabled] Detects the idle state of system and reduce CPU power consumption accordingly.

[Disabled] Disable this function.

► Super IO Configuration

Advanced		Enable or Disable Serial Port (COM)
Super IO Configuration		
Serial Port1	[Enabled]	
Device Settings	IO=3F8h; IRQ=4;	
Change Settings	[Auto]	
Mode Select	[RS232]	
Serial Port2	[Enabled]	
Device Settings	IO=2F8h; IRQ=3;	
Change Settings	[Auto]	
Serial Port3	[Enabled]	
Device Settings	IO=3E8h; IRQ=7;	
Change Settings	[Auto]	
Serial Port4	[Enabled]	
Device Settings	IO=2E8h; IRQ=7;	
Change Settings	[Auto]	
Serial Port5	[Enabled]	
Device Settings	IO=2F0h; IRQ=7;	
Change Settings	[Auto]	
Serial Port6	[Enabled]	
Device Settings	IO=2E0h; IRQ=7;	
Change Settings	[Auto]	
FIFO Mode	[128-byte]	
Shared IRQ Mode	[Edge/Low Active]	
Watch Dog Timer	[Disabled]	
		++: Select Screen T4: Select Item Enter: Select +/-: Change Opt. ESC: Exit F1: General Help F7: Previous Values F9: Optimized Defaults F10: Save & Reset setup F12: Screenshot capture <>: Scroll help area upwards <M>: Scroll help area downwards

► Serial Port 1/ 2/ 3/ 4/ 5/ 6

This setting enables or disables the specified serial port.

» Device Settings

This setting shows the address & IRQ of the specified serial port.

» Change Settings

This setting is used to change the address & IRQ settings of the specified serial port.

» Mode Select

Select an operation mode for Serial Port 1/ 2/ 3/ 4.

► FIFO Mode

This setting controls the FIFO (First In First Out) data transfer mode.

► Shared IRQ Mode

This setting provides the system with the ability to share interrupts among its serial ports.

► Watch Dog Timer

You can enable the system watchdog timer, a hardware timer that generates a reset when the software that it monitors does not respond as expected each time the watchdog polls it.

► **H/W Monitor (PC Health Status)**

These items display the current status of all monitored hardware devices/ components such as voltages, temperatures and all fans' speeds.

Advanced	
Pc Health Status	
Thermal Shutdown	[Disabled]
CPU temperature	: +33 C
System temperature 1	: +28 C
System temperature 2	: +28 C
CPUFAN	: N/A
SYSFAN1	: 4000 RPM
SYSFAN2	: N/A
VCC_CORE	: +0.872 V
VCC3	: +3.360 V
VCC5	: +4.918 V
+12V	: +12.232 V
VCC3V	: +3.376 V
VSB3V	: +3.360 V
VSB5V	: +4.920 V
VBAT	: +3.040 V
Thermal Shutdown ++: Select Screen T: Select Item Enter: Select +/-: Change Opt. ESC: Exit F1: General Help F7: Previous Values F9: Optimized Defaults F10: Save & Reset setup F12: Screenshot capture <k>: Scroll help area upwards <m>: Scroll help area downwards	

► **Thermal Shutdown**

This setting determines the behavior of the system when the CPU temperature reaches a predefined threshold.

[Enabled] Initiate an automatic shutdown of the system to protect from potential damage due to overheating.

[Disabled] Disable this function.

► **Smart Fan Configuration**

Advanced	
Configuration Smart FAN	
CPUFAN	[Disabled]
SYSFAN1	[Disabled]
SYSFAN2	[Disabled]
Disabled/Enabled Smart FAN Function	

► **CPUFAN/ SYSFAN1/ SYSFAN2**

This setting enables or disables the Smart Fan function. Smart Fan is an excellent feature which will adjust the CPU/system fan speed automatically depending on the current CPU/system temperature, avoiding the overheating to damage your system. The following item will display when CPUFAN/ SYSFAN1/ SYSFAN2 is enabled.

» **Min. Speed (%)**

The beginning speed of the System fan.

► PCI/PCIE Device Configuration

Advanced		
Audio Controller	[Enabled]	Control Detection of the Audio Controller. Disabled = Audio Controller will be unconditionally disabled. Enabled = Audio Controller will be unconditionally Enabled.

► Audio Controller

This setting enables or disables the detection of the onboard audio controller.

► Network Stack Configuration

This menu provides Network Stack settings for users to enable network boot (PXE) from BIOS.

Advanced		
Network Stack	[Disabled]	Enable/Disable UEFI Network Stack

► Network Stack

This menu provides Network Stack settings for users to enable network boot (PXE) from BIOS. The following items will display when **Network Stack** is enabled.

» **IPV4 PXE Support**

Enables or disables IPv4 PXE boot support.

» **IPV4 HTTP Support**

Enables or disables Ipv4 HTTP Support.

» **IPV6 PXE Support**

Enables or disables Ipv6 PXE Support.

» **IPV6 HTTP Support**

Enables or disables Ipv6 HTTP Support.

» **PXE boot wait time**

Use this option to specify the wait time to press the ESC key to abort the PXE boot. Press “+” or “-” on your keyboard to change the value. The default setting is 0.

» **Media detect count**

Use this option to specify the number of times media will be checked. Press “+” or “-” on your keyboard to change the value. The default setting is 1.

► **GPIO Group Configuration**

Advanced		
GPIO Group Configuration		Set GPIO to output High/Low
GPIO0	[Low]	
GPIO1	[Low]	
GPIO2	[Low]	
GPIO3	[Low]	

► **GPIO ~ GPIO3**

These settings control the operation mode of the specified GPIO.

► **PCIe ASPM settings**

This menu provide settings for PCIe ASPM (Active State Power Management) level for different installed devices.

Advanced		
PCIe1	[L1]	PCI Express Active State Power Management settings
PCIe2/4/5/6/7	[Disabled]	
PCIe3	[Disabled]	

► **PCIe1, PCIe2/4/5/6/7, PCIe3**

Sets PCI Express ASPM (Active State Power Management) state for power saving.

- [L0s] Initiate an automatic shutdown of the system to protect from potential damage due to overheating.
- [L1] Higher latency, lower power “standby” state (**optional**).
- [L0sL1] Activate both L0s and L1 support.
- [Disabled] Disable this function.

Boot

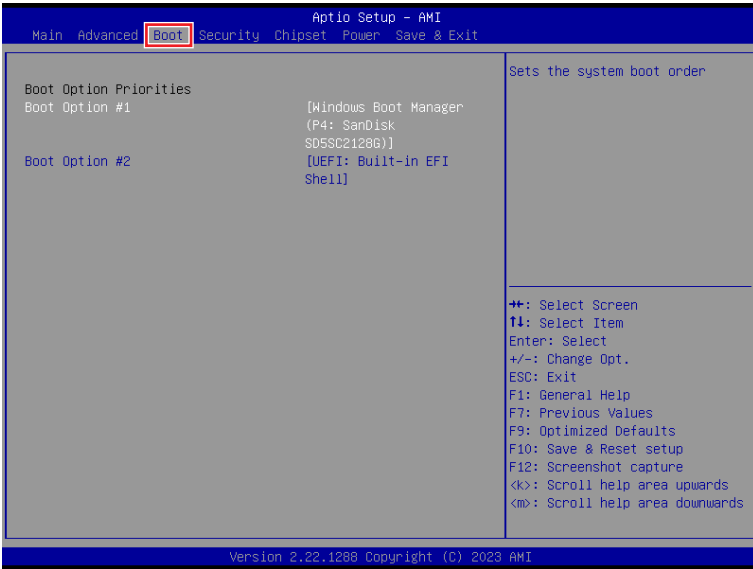

► Boot Option #1-2

This setting allows users to set the sequence of boot devices where BIOS attempts to load the disk operating system.

Security

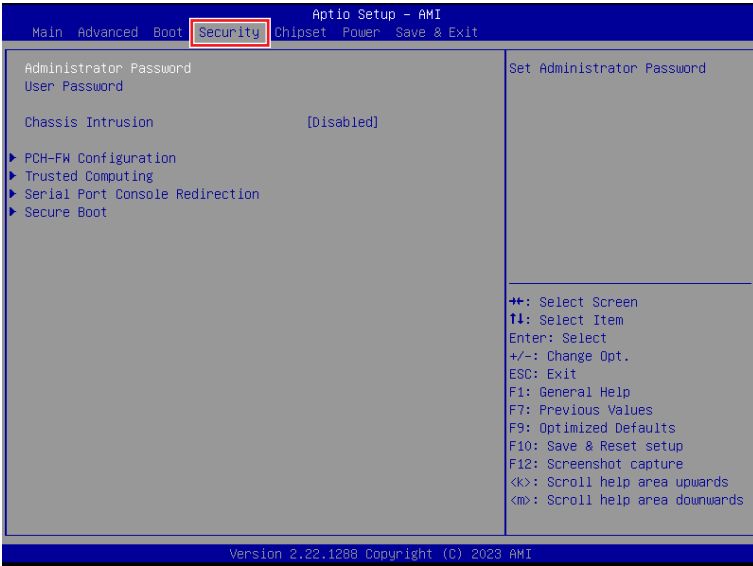

► Administrator Password

Administrator Password controls access to the BIOS Setup utility.

► User Password

User Password controls access to the system at boot and to the BIOS Setup utility.

► Chassis Intrusion

Enables or disables recording messages while the chassis is opened. This function is ready for the chassis equips a chassis intrusion jumper (switch).

[Enabled] Once the chassis is **opened**, the system will record and issue a warning message. A beep sound will be emitted before this function is reset.

[Disabled] Once the chassis is **closed**, the system will record and issue a warning message.

[Reset] Clear the warning message. After clearing the message, please return to Enabled or Disabled.

► PCH-FW Configuration

This menu allows you to configure settings related to the PCH firmware.

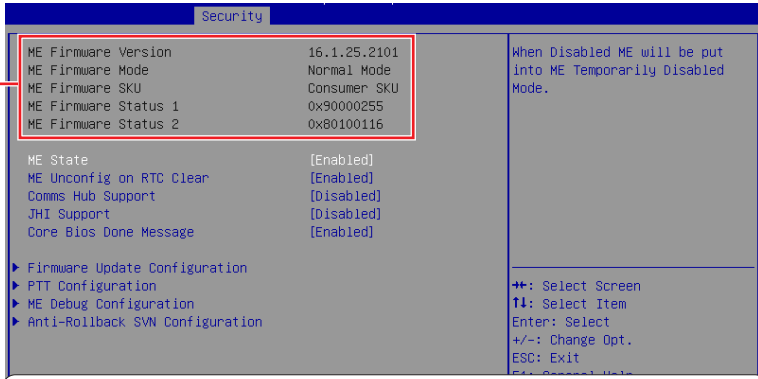

The screenshot shows the BIOS Security menu with the following settings:

ME Firmware Version	16.1.25.2101	When Disabled ME will be put into ME Temporarily Disabled Mode.
ME Firmware Mode	Normal Mode	
ME Firmware SKU	Consumer SKU	
ME Firmware Status 1	0x90000255	
ME Firmware Status 2	0x80100116	
ME State	[Enabled]	++: Select Screen ↑↓: Select Item Enter: Select +/-: Change Opt. ESC: Exit F10: Save & Exit
ME Unconfig on RTC Clear	[Enabled]	
Comms Hub Support	[Disabled]	
JHI Support	[Disabled]	
Core Bios Done Message	[Enabled]	
► Firmware Update Configuration		
► PTT Configuration		
► ME Debug Configuration		
► Anti-Rollback SVN Configuration		

Firmware Information

ME Firmware Version	ME Firmware SKU
ME Firmware Mode	ME Firmware Status 1-2

These settings show the firmware information of the Intel ME (Management Engine).

► ME State

This menu controls the Intel® Management Engine State (ME state) parameters, which provides various management and security capabilities. The following items will display when **ME State** is enabled.

» ME Unconfig on RTC Clear

Enables or disables ME Unconfig on RTC Clear. Enabling this item resets the ME configuration to its default state, removing any customizations or settings applied.

» Comms Hub Support

Enables or disables the communications hub support.

» JHI Support

Enables or disables JHI Support. JHI stands for Intel® Dynamic Application Loader Host Interface Service (Intel® DAL HIS) and is the engineering name for this feature. Enabling JHI Support in the BIOS settings allows the system to utilize this interface for communication between trusted applications and host-based applications.

» Core BIOS Done Message

Enables or disables Core BIOS Done Message sent to ME.

► Firmware Update Configuration

Security		
Me FW Image Re-Flash	[Disabled]	Enable/Disable Me FW Image Re-Flash function.
Local FW Update	[Enabled]	

» ME FW Image Re-Flash

Enables or disables the ME Firmware Image Re-flashing.

» Local FW Update

Enables or disables the capability to perform a firmware update of the ME locally.

► PTT Configuration

Intel® Platform Trust Technology (PTT) is a platform functionality for credential storage and key management used by Microsoft Windows.

Security		
PTT Capability / State	1 / 0	Selects TPM device: PTT or dTPM. PTT - Enables PTT in SkuMgr dTPM 1.2 - Disables PTT in SkuMgr Warning ! PTT/dTPM will be disabled and all data saved on it will be lost.
TPM Device Selection	[dTPM]	

» TPM Device Selection

Select TPM (Trusted Platform Module) devices from PTT or dTPM (Discrete TPM).

[PTT] Enables PTT in SkuMgr.

[dTPM] Disables PTT in SkuMgr. **Warning! PTT/ dTPM will be disabled and all data saved on it will be lost.**

► ME Debug Configuration

This menu allows you to configure debug-related options for the Intel® Management Engine (ME).

Security		
HECI Timeouts	[Enabled]	Enable/Disable HECI Send/Receive Timeouts.
Force ME DID Init Status	[Disabled]	
CPU Replaced Polling Disable	[Disabled]	
HECI Message check Disable	[Disabled]	
MBP HOB Skip	[Disabled]	
HECI2 Interface Communication	[Disabled]	
KT Device	[Enabled]	
End Of Post Message	[Send in DXE]	
DoI3 Setting for HECI Disable	[Disabled]	
MCTP Broadcast Cycle	[Disabled]	

» HECI Timeouts

This setting enables/ disables the HECI (Host Embedded Controller Interface) send/ receive timeouts.

» Force ME DID Init Status

Forces the ME Device ID (DID) initialization status value.

» CPU Replaced Polling Disable

Setting this option disables the CPU replacement polling loop.

- » **HECI Message Check Disable**
This setting disables message check for BIOS boot path when sending messages.
- » **MBP HOB Skip**
Setting this option will skip ME's Memory-Based Protection (MBP) HOB region.
- » **HECI2 Interface Communication**
This setting Adds/ Removes HECI2 device from PCI space.
- » **KT Device**
Enables or disables Key Transfer (KT) Device.
- » **End of Post Message**
Enables or disables End of Post Message sent to ME.
- » **DOI3 Setting for HECI Disable**
Setting this option disables setting DOI3 bit for all HECI devices.
- » **MCTP Broadcast Cycle**
Enables or disables Management Component Transport Protocol (MCTP) Broadcast Cycle.

► **Anti-Rollback SVN Configuration**

Security		
Minimal Allowed Anti-Rollback SVN	0	When enabled, hardware-enforced Anti-Rollback mechanism is automatically activated: once ME FW was successfully run on a platform, FW with lower ARB-SVN will be blocked from execution
Executing Anti-Rollback SVN	4	
Automatic HW-Enforced Anti-Rollback SVN	[Disabled]	
Set HW-Enforced Anti-Rollback for Current SVN	[Disabled]	

- » **Automatic HW-Enforced Anti-Rollback SVN**
Setting this item enables will automatically activate the hardware-enforced anti-rollback protection based on the Secure Version Number (SVN). Once enabled, the hardware will enforce that only firmware updates with an SVN equal to or higher than the current SVN can be installed.
- » **Set HW-Enforced Anti-Rollback for Current SVN**
Enable HW ERB mechanism for current ARB SVN value. FW with lower ARB-SVN will be blocked from execution. The value will be restored to disable after the command is sent. This item will display when **Automatic HW-Enforced Anti-Rollback SVN** is enabled.

► Trusted Computing

Security		
TPM 2.0 Device Found		Enables or Disables BIOS support for security device. O.S. will not show Security Device, TCG EFI protocol and INT1A interface will not be available.
Firmware Version:	15.22	
Vendor:	IFX	
Security Device Support	[Enable]	
Active PCR banks	SHA256	
Available PCR banks	SHA256,SHA384	
SHA256 PCR Bank	[Enabled]	
SHA384 PCR Bank	[Disabled]	
Pending operation	[None]	
Platform Hierarchy	[Enabled]	
Storage Hierarchy	[Enabled]	
Endorsement Hierarchy	[Enabled]	
Physical Presence Spec Version	[1.3]	
TPM 2.0 InterfaceType	[TIS]	
Device Select	[2.0]	
		++: Select Screen T4: Select Item Enter: Select +/-: Change Opt. ESC: Exit F1: General Help F7: Previous Values F9: Optimized Defaults F10: Save & Reset setup F12: Screenshot capture <k>: Scroll help area upwards <m>: Scroll help area downwards

► Security Device Support

This item enables or disables BIOS support for security device. When set to [Disable], the OS will not show security device.

► SHA256 PCR Bank, SHA384 PCR Bank

These settings enables or disables the SHA256 PCR Bank and SHA384 PCR Bank.

► Pending Operation

When **Security Device Support** is set to [Enable], **Pending Operation** will appear. It is advised that users should routinely back up their TPM secured data.

[TPM Clear] Clear all data secured by TPM.

[None] Discard the se lection.

► Platform Hierarchy, Storage Hierarchy, Endorsement Hierarchy

These settings enables or disables the Platform Hierarchy, Storage Hierarchy and Endorsement Hierarchy.

► Physical Presence Spec Version

This settings show the Physical Presence Spec Version.

► TPM 2.0 Interface Type

This setting shows the TPM 2.0 Interface Type.

► Device Select

Select your TPM device through this setting.

► Serial Port Console Redirection

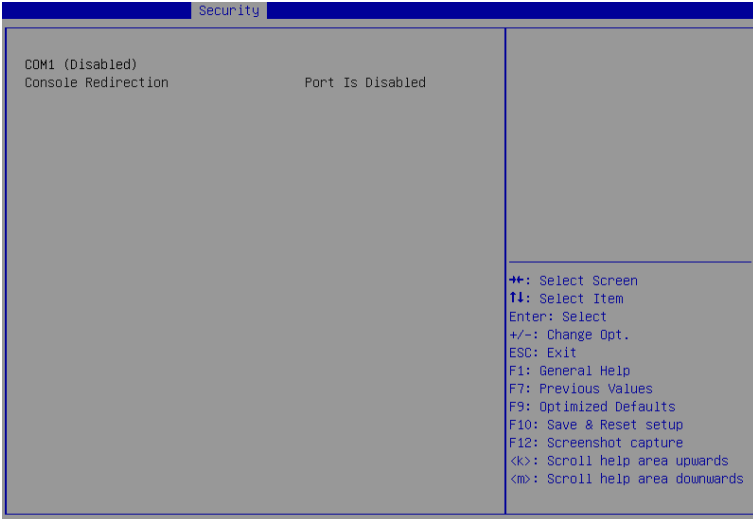

► Console Redirection

Console Redirection operates in host systems that do not have a monitor and keyboard attached. This setting enables or disables the operation of console redirection. When set to [Enabled], BIOS redirects and sends all contents that should be displayed on the screen to the serial COM port for display on the terminal screen. Besides, all data received from the serial port is interpreted as keystrokes from a local keyboard.

► Console Redirection Settings (COM1)

This option appears when Console Redirection is **enabled**.

» Terminal Type

To operate the system's console redirection, you need a terminal supporting ANSI terminal protocol and a RS-232 null modem cable connected between the host system and terminal(s). You can select emulation for the terminal from this setting.

- [ANSI] Extended ASCII character set.
- [VT100] ASCII character set.
- [VT100Plus] Extends VT100 to support color, function keys, etc.
- [VT-UTF8] Uses UTF8 encoding to map Unicode characters onto one or more bytes.

» Bits per second, Data Bits, Parity, Stop Bits

This setting specifies the transfer rate (bits per second, data bits, parity, stop bits) of Console Redirection.

» Flow Control

Flow control is the process of managing the rate of data transmission between two nodes. It's the process of adjusting the flow of data from one device to another to ensure that the receiving device can handle all of the incoming data. This is particularly important where the sending device is capable of sending data much faster than the receiving device can receive it.

» VT-UTF8 Combo Key Support

This setting enables or disables the VT-UTF8 combination key support for ANSI/VT100 terminals.

» Recorder Mode, Resolution 100x31

This setting enables or disables the recorder mode and the resolution 100x31.

» Putty KeyPad

PuTTY is a terminal emulator for Windows. This setting controls the numeric keypad for use in PuTTY.

► Secure Boot

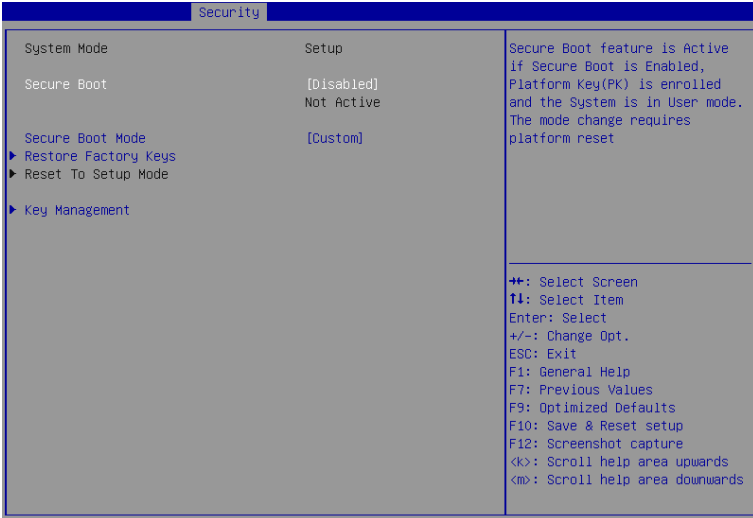

► Secure Boot

Secure Boot function can be enabled only when the **Platform Key (PK)** is enrolled and running accordingly.

► Secure Boot Mode

Selects the secure boot mode. This item appears when **Secure Boot** is enabled.

[Standard] The system will automatically load the secure keys from BIOS.

[Custom] Allows user to configure the secure boot settings and manually load the secure keys.

► Restore Factory Keys

Allows you to restore all factory default keys. The settings will be applied after reboot or at the next reboot. This item appears when "**Secure Boot Mode**" sets to [Custom].

► Reset to setup Mode

Allows you to delete all the Secure Boot keys (PK,KEK,db,dbt,dbx). The settings will be applied after reboot or at the next reboot. This item appears when "**Secure Boot Mode**" sets to [Custom].

► Key Management

Press **Enter** key to enter the sub-menu. Manage the secure boot keys. This item appears when "**Secure Boot Mode**" sets to [Custom].

Chipset

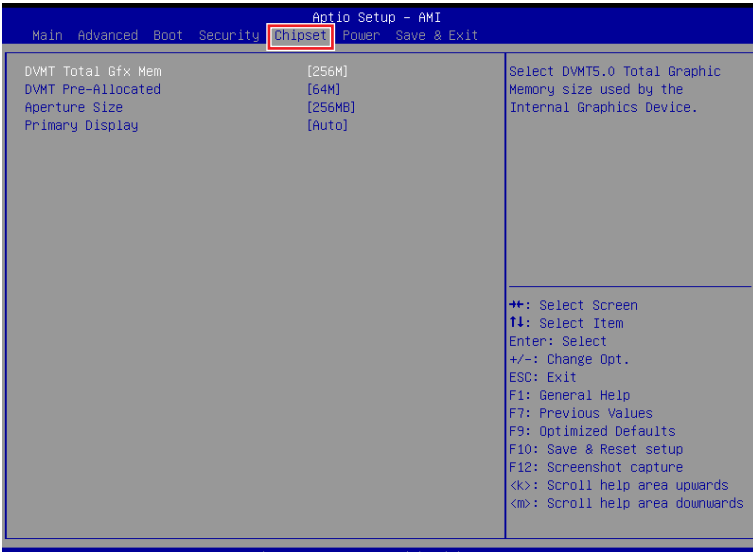

► DVMT Total Gfx Mem

This setting specifies the total graphics memory size for Dynamic Video Memory Technology (DVMT).

► DVMT Pre-Allocated

This setting defines the DVMT pre-allocated memory. Pre-allocated memory is the small amount of system memory made available at boot time by the system BIOS for video. Pre-allocated memory is also known as locked memory. This is because it is “locked” for video use only and as such, is invisible and unable to be used by the operating system.

► Aperture Size

This setting specifies the aperture size of the integrated graphics.

► Primary Display

Use the field to select the primary display of the system.

Power

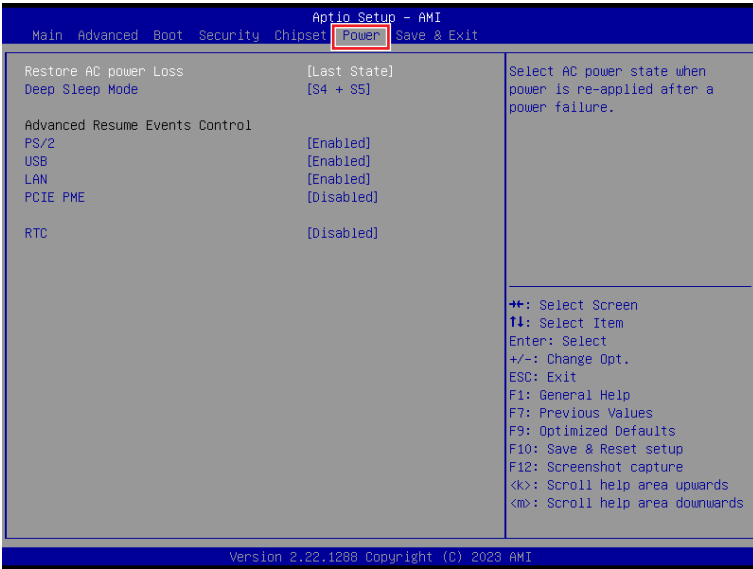

► Restore AC Power Loss

This setting specifies whether your system will reboot after a power failure or interrupt occurs. Available settings are:

- [Power Off] Leaves the computer in the power off state.
- [Power On] Leaves the computer in the power on state.
- [Last State] Restores the system to the previous status before power failure or interrupt occurred.

► Deep Sleep Mode

The setting enables or disables the Deep S5 power saving mode. S5 is almost the same as G3 Mechanical Off, except that the PSU still supplies power, at a minimum, to the power button to allow return to S0. A full reboot is required. No previous content is retained. Other components may remain powered so the computer can “wake” on input from the keyboard, clock, modem, LAN, or USB device.

► PS/2, USB, LAN, PCIE PME

The setting allows the activity of the specified device to wake up the system from power saving modes.

► RTC

When [Enabled], you can set the date and time at which the RTC (real-time clock) alarm awakens the system from power saving modes.

Save & Exit

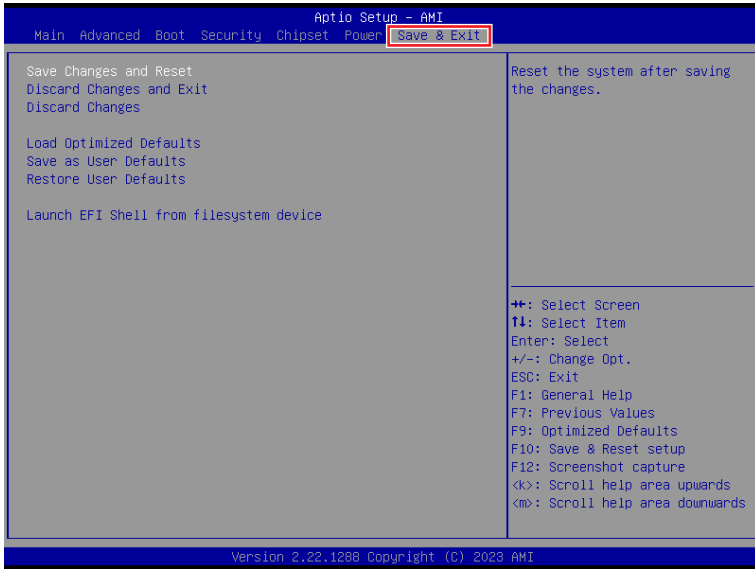

- ▶ **Save Changes and Reset**
Save changes to CMOS and reset the system.
- ▶ **Discard Changes and Exit**
Abandon all changes and exit the Setup Utility.
- ▶ **Discard Changes**
Abandon all changes.
- ▶ **Load Optimized Defaults**
Use this menu to load the default values set by the motherboard manufacturer specifically for optimal performance of the motherboard.
- ▶ **Save as User Defaults**
Save changes as the user's default profile.
- ▶ **Restore User Defaults**
Restore the user's default profile.
- ▶ **Launch EFI Shell from filesystem device**
This setting helps to launch the EFI Shell application from one of the available file system devices.

GPIO WDT Programming

This chapter provides WDT (Watch Dog Timer), GPIO (General Purpose Input/ Output) and LVDS Backlight programming guide.

Abstract

In this section, code examples based on C programming language provided for customer interest. **Inportb**, **Outportb**, **Inportl** and **Outportl** are basic functions used for access IO ports and defined as following.

Inportb: Read a single 8-bit I/O port.

Outportb: Write a single byte to an 8-bit port.

Inportl: Reads a single 32-bit I/O port.

Outportl: Write a single long to a 32-bit port.

General Purpose IO

1. General Purposed IO – GPIO/DIO

The GPIO port configuration addresses are listed in the following table:

Name	IO Port	IO address	Name	IO Port	IO address
N_GPIO0	0xA02	Bit 7	N_GPO0	0xA02	Bit 3
N_GPIO1	0xA02	Bit 6	N_GPO1	0xA02	Bit 2
N_GPIO2	0xA02	Bit 5	N_GPO2	0xA02	Bit 1
N_GPIO3	0xA02	Bit 4	N_GPO3	0xA02	Bit 0

1.1 Set output value of GPO

1. Read the value from GPO port.
2. Set the value of GPO address.
3. Write the value back to GPO port.

Example: Set N_GPO0 output “high”

```
val = Inportb (0xA02);           // Read value from N_GPO0 port.
val = val | (1<<3);              // Set N_GPO0 address (bit 3) to 1 (output “high”).
Outportb (0xA02, val);          // Write back to N_GPO0 port.
```

Example: Set N_GPO1 output “low”

```
val = Inportb (0xA02);           // Read value from N_GPO1 port.
val = val & (~(1<<2));          // Set N_GPO1 address (bit 2) to 0 (output “low”).
Outportb (0xA02, val);          // Write back to N_GPO1 port.
```

1.2 Read input value from GPI

1. Read the value from GPI port.
2. Get the value of GPI address.

Example: Get N_GPI2 input value.

```
val = Inportb (0xA02);           // Read value from N_GPI2 port.
val = val & (1<<5);             // Read N_GPI2 address (bit 5).
if (val) printf (“Input of N_GPI2 is High”);
else printf (“Input of N_GPI2 is Low”);
```

Watchdog Timer

2. Watchdog Timer – WDT

The base address (WDT_BASE) of WDT configuration registers is [0xA10](#).

2.1 Set WDT Time Unit

```
val = Inportb (WDT_BASE + 0x05); // Read current WDT setting
val = val | 0x08; // minute mode. val = val & 0xF7 if second mode
Outportb (WDT_BASE + 0x05, val); // Write back WDT setting
```

2.2 Set WDT Time

```
Outportb (WDT_BASE + 0x06, Time); // Write WDT time, value 1 to 255.
```

2.3 Enable WDT

```
val = Inportb (WDT_BASE + 0x0A); // Read current WDT_PME setting
val = val | 0x01; // Enable WDT OUT: WDOUT_EN (bit 0) set to 1.
Outportb (WDT_BASE + 0x0A, val); // Write back WDT setting.
val = Inportb (WDT_BASE + 0x05); // Read current WDT setting
val = val | 0x20; // Enable WDT by set WD_EN (bit 5) to 1.
Outportb (WDT_BASE + 0x05, val); // Write back WDT setting.
```

2.4 Disable WDT

```
val = Inportb (WDT_BASE + 0x05); // Read current WDT setting
val = val & 0xDF; // Disable WDT by set WD_EN (bit 5) to 0.
Outportb (WDT_BASE + 0x05, val); // Write back WDT setting.
```

2.5 Check WDT Reset Flag

If the system has been reset by WDT function, this flag will set to 1.

```
val = Inportb (WDT_BASE + 0x05); // Read current WDT setting.
val = val & 0x40; // Check WDTMOUT_STS (bit 6).
if (val) printf ("timeout event occurred");
else printf ("timeout event not occurred");
```

2.6 Clear WDT Reset Flag

```
val = Inportb (WDT_BASE + 0x05); // Read current WDT setting
val = val | 0x40; // Set 1 to WDTMOUT_STS (bit 6);
Outportb (WDT_BASE + 0x05, val); // Write back WDT setting
```